

HOBBIE GETAWAY PARTS

REPLACEMENT HULL - left 37010001
 REPLACEMENT HULL - right 37020001

EZ LOC RUDDER PINTLES
 UPPER PINTLE 90880211
 LOWER PINTLE 90880221

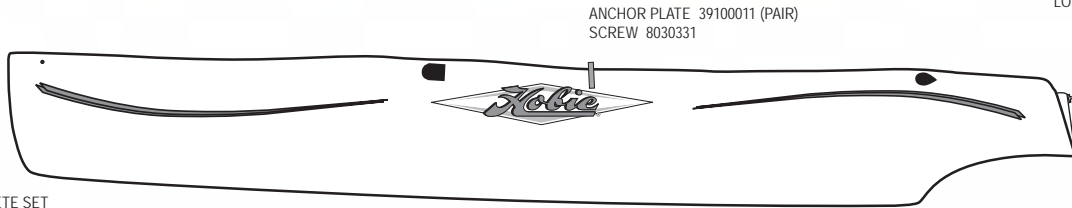

ANCHOR PLATE 39100011 (PAIR)
 SCREW 8030331

SCREW 8030171
 SCREW (2009+) 8030331

DRAIN PLUG
 W / GASKET 10091000

DECALS -
 37440150 "CURLS" COMPLETE SET
 37440151 "GETAWAY" EACH
 12451061 "Hobie" Diamond 36" Silver

BOW SPREADER 37500001

BOW TANG 20120000

END BLOCK 37500031
 RIVET 8010201 (4)
 BOLT 8030291
 WASHER 8080671

BOLT 8040341
 NUT 8050311
 PLATE 37500021
 RIVET 8010181



MAST STEP POST 37170001
 MAST STEP BALL 30110001
 WASHER 8080711
 NUT 8050151

CLAM CLEAT 37380001
 FWD CROSSBAR 37131910
 SWIVEL CLEAT 50007 DEAD EYE 71220001



CROSS BAR STOP PLATE 38132001
 RIVET 8010181 (3)

REAR CROSSBAR 37191910
 TRAVELER SWIVEL CAM PLATE 37760041
 SWIVEL CLEAT 50007
 REAR END CAP 37201021



CROSS BAR STOP PLATE 38132001
 RIVET 8010181 (3)

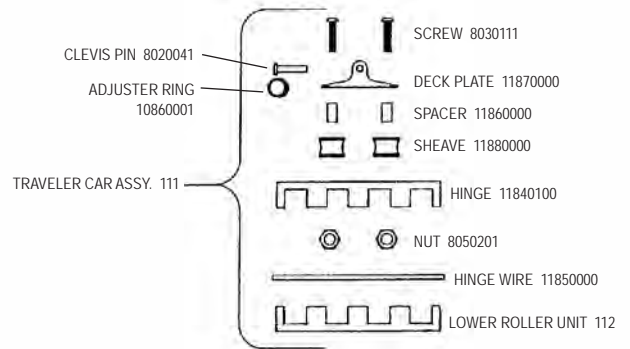

CLEVIS PIN 8020041
 ADJUSTER RING 10860001

SCREW 8030111

DECK PLATE 11870000
 SPACER 11860000
 SHEAVE 11880000

HINGE 11840100

NUT 8050201

HINGE WIRE 11850000

LOWER ROLLER UNIT 112

ORIGINAL HATCH 37370021*
 MOUNT TO HULL GASKET 37370031
 SCREWS 8031151
 5" HATCH (INSIDE) 41370001
 * Replacement "O" Ring Seal
 # SPA-4SEAL-S Available from imtra.com
 Not stocked by Hobie Cat

HOBBIE TWIST AND SEAL HATCH 71710001
 GASKET 71707002 (REQ 2)
 SCREWS 8032121 (REQ 14)
 5" HATCH (INSIDE) 41370001

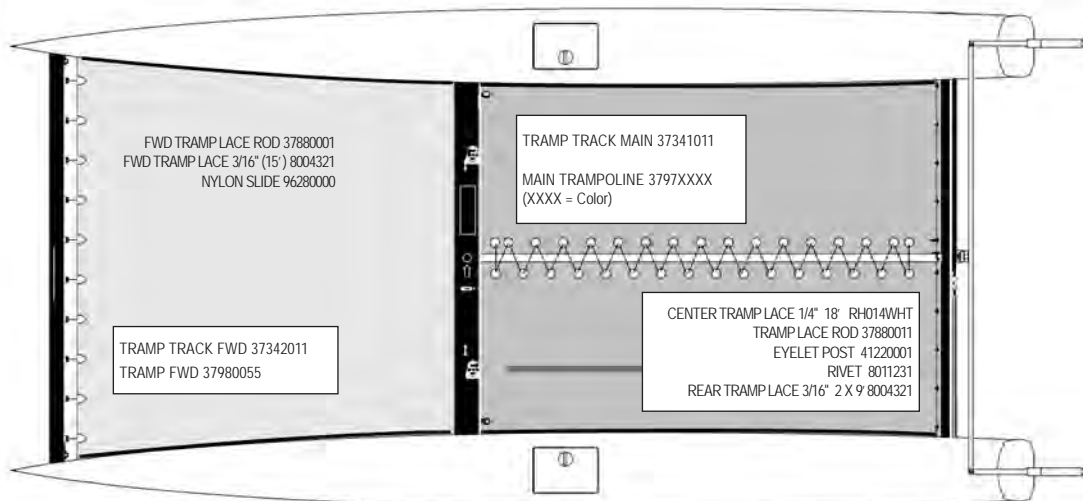

FWD TRAMP LACE ROD 37880001
 FWD TRAMP LACE 3/16" (15') 8004321
 NYLON SLIDE 96280000

TRAMP TRACK FWD 37342011
 TRAMP FWD 37980055

TRAMP TRACK MAIN 37341011

MAIN TRAMPOLINE 3797XXXX
 (XXXX = Color)

CENTER TRAMP LACE 1/4" 18' RH014WHT
 TRAMP LACE ROD 37880001
 EYELET POST 41220001
 RIVET 8011231
 REAR TRAMP LACE 3/16" 2 X 9 8004321

FIBERGLASS EXTENSION WITH HINGE 20550001 (84")
(GETAWAY OEM CUT TO 60")

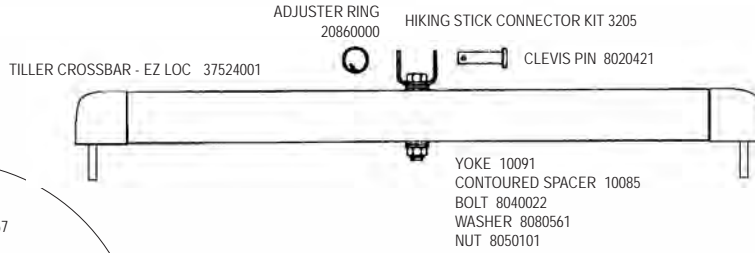

MAST ASSEMBLY 37610000

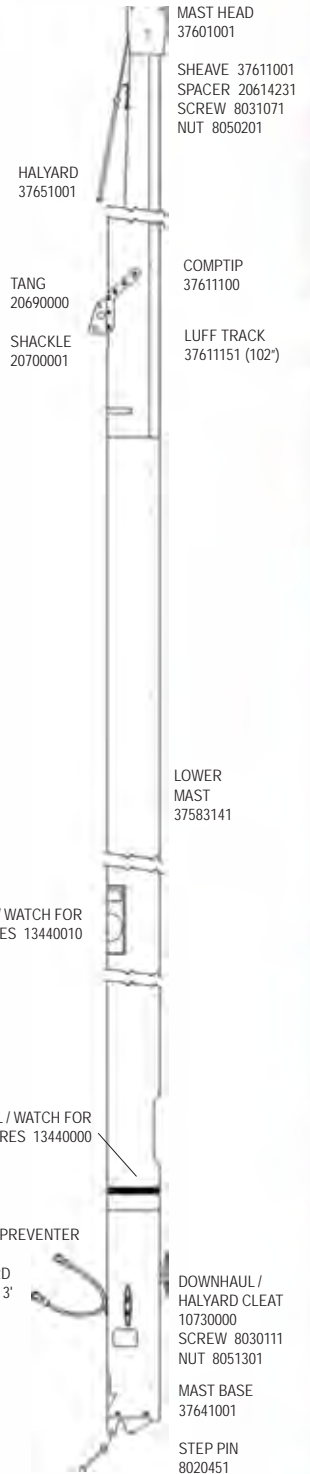

TILLER CONNECTOR 1957

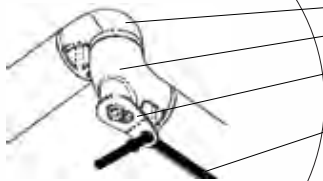

RUDDER ASSEMBLY - EZ LOC 37312000

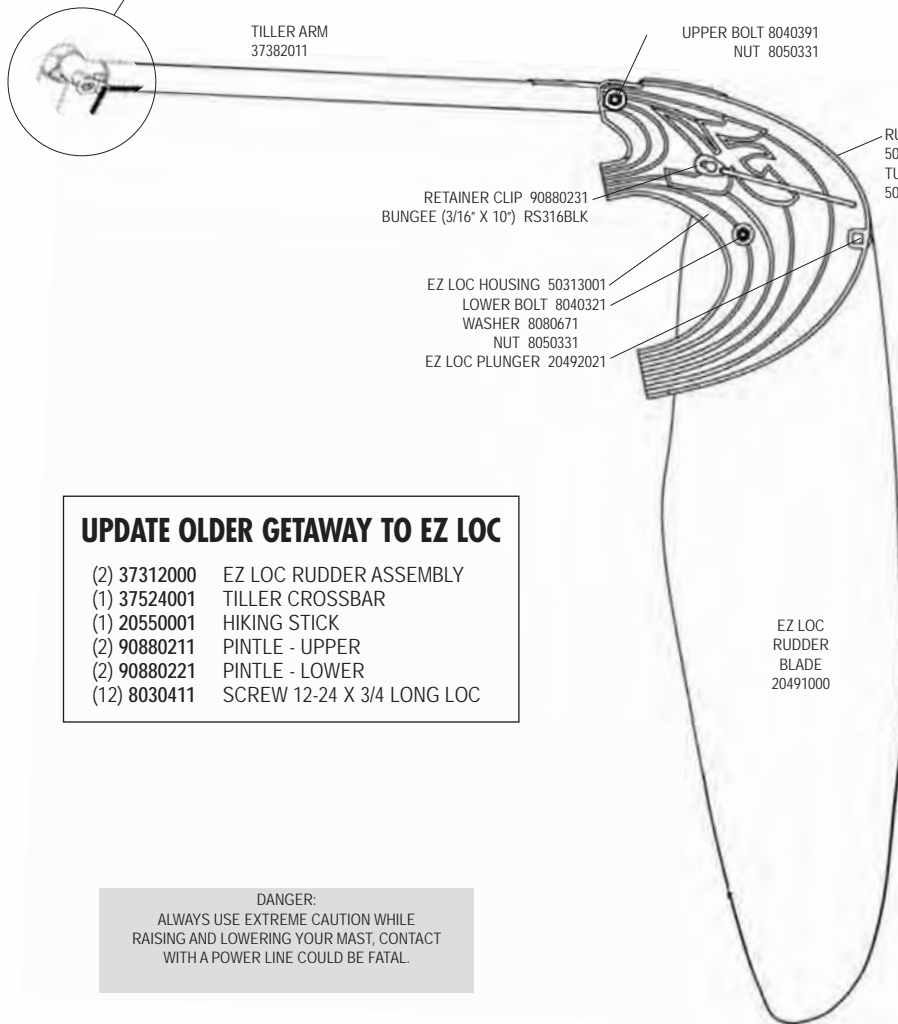

UPDATE OLDER GETAWAY TO EZ LOC

- (2) 37312000 EZ LOC RUDDER ASSEMBLY
- (1) 37524001 TILLER CROSSBAR
- (1) 20550001 HIKING STICK
- (2) 90880211 PINTLE - UPPER
- (2) 90880221 PINTLE - LOWER
- (12) 8030411 SCREW 12-24 X 3/4 LONG LOC

DANGER:
ALWAYS USE EXTREME CAUTION WHILE RAISING AND LOWERING YOUR MAST, CONTACT WITH A POWER LINE COULD BE FATAL.



FORESTAY ASSY 37810001
 FORESTAY ASSY INCLUDES:
 *SHACKLE W/KEEPER WIRE 20700001
 *SWIVEL 61230000
 *YOKE 37810030
 *SCREW HSPAP
 *LOCK NUT 8050111
 *LOWER FORESTAY 37810021

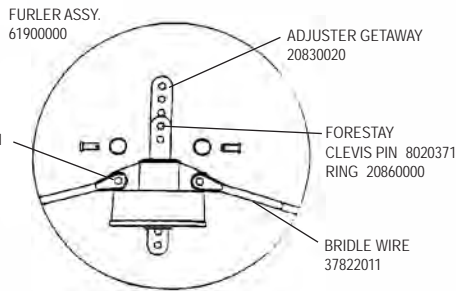

ROLLER FURLER DETAIL

FURLER TUNE UP KIT 61900900
 INCLUDES: BEARINGS, BEARING CAGE, NYLINER, NYLON SLEEVE, DARBY RINGS, SPOOL, HOUSING

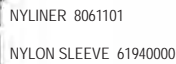
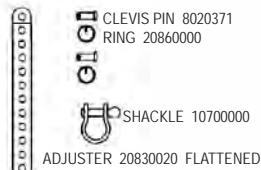

FURLER ASSY. 61900000

NOT SHOWN
 LINE RH018WHT X 18"
 SCREW 8030501

SHROUDS

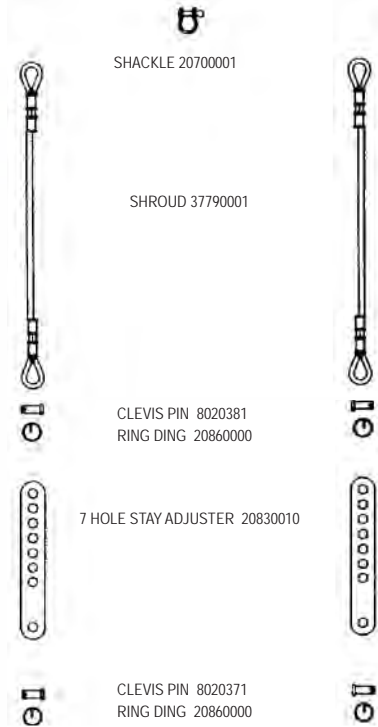

SHACKLE 20700001

SHROUD 37790001

CLEVIS PIN 8020381
 RING DING 20860000

7 HOLE STAY ADJUSTER 20830010

CLEVIS PIN 8020371
 RING DING 20860000



LEECH BATTEN TIP (TOP) 21333000

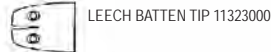

LEECH BATTEN TIP 11323000



LUFF BATTEN TIP 11322011

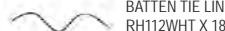

BATTEN TIE LINE RH112WHT X 18"

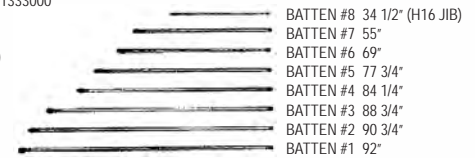

37016001 BATTEN SET
 (FOR INDIVIDUAL BATTENS SEE UNIVERSAL BATTENS IN CATALOG)

BATTEN #8 34 1/2" (H16 JIB)
 BATTEN #7 55"
 BATTEN #6 69"
 BATTEN #5 77 3/4"
 BATTEN #4 84 1/4"
 BATTEN #3 88 3/4"
 BATTEN #2 90 3/4"
 BATTEN #1 92"

FLOAT KIT 30119
 SCREW 8032011

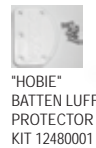

"HOBIE" BATTEN LUFF PROTECTOR KIT 12480001

MAIN SAIL 37991XXX
 JIB SAIL 37992XXX

SEE SEQUENTIAL PRICE LIST OR SAIL COLOR SELECTION IN CATALOG

"S" HOOK 38900031
 SHACKLE 11220000
 UPPER BLOCK 37900021

MAIN SHEET RM038RED X 38'

LOWER BLOCK 37900011
 CAM CLEAT RF5011
 CAM CLEAT RF5015
 FAIRLEAD 8030241
 SCREW (2)

JIB COVER 1815
 SNAP HOOK 53790040

JIB HOOK 53790141
 CLEW BLOCK 20680000

JIB SHEET RM516BLU X 32'
 DOWNHAUL RH014WHT X 5'

RIGHTING LINE SYSTEM 30109

MODEL / YEAR / ACCESSORY VARIATIONS

TILLER CROSSBAR 37521001 (OLDER RUDDER CASTINGS / M20 STYLE CONNECTORS)
 TILLER CROSSBAR 37522001 (OLDER RUDDER CASTINGS / TENDON STYLE CONNECTORS)
 TILLER CROSSBAR 37523001 (EZ LOC RUDDERS / TENDON CONNECTORS)

OLDER TILLER CONNECTOR PARTS

CLUB TILLER CONNECTOR (1954 / 1956)

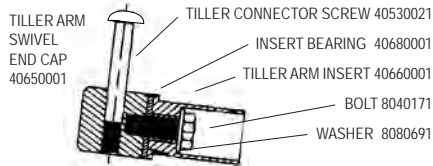

1956 KIT - CLUB TILLER CONNECTOR
 (REPLACES TENDON STYLE WITH CLUB BOLT STYLE)
 1954 KIT - CLUB TILLER CONNECTOR / UPGRADE FOR EARLY BOATS
 WITH ORIGINAL CURVED TENDON CONNECTORS:
 INCLUDES TILLER CROSS BAR AND ALL TILLER CONNECTOR FITTINGS

TENDON TILLER CONNECTOR

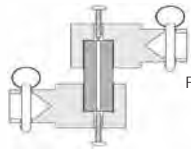

ENDCAP 37561001
 FIBER TENDON 37561011
 FIBER-TENDON SCREW 8030071
 QUICK PIN 8020461
 LANYAD 37661091

RUDDER PARTS

Pre-"EZ LOC" Rudder System

* = SUB ASSEMBLY PART / INCLUDED WITH CASTING

ALUMINUM RUDDER CASTINGS

UPPER PINTLE 38101301
 LOWER PINTLE 38101401
 KEEPER PIN W/ LANYARD 38490011

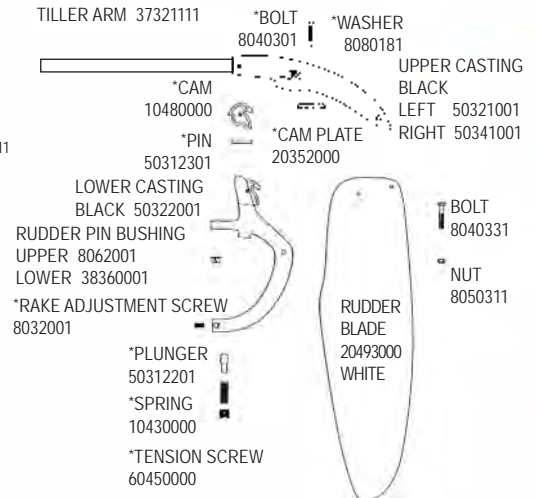

37001000 GETAWAY WING ASSEMBLY (WITH COVER)



GETAWAY RIVET GUIDE

() INDICATES QUANTITY NEEDED TO FASTEN PART

MAST
 HEAD 8010121 (2)
 HALYLARD HOOK 8011231 (2)
 TANG 8010121 (12)
 8011291 (12)
 BUNGEE PAD EYE 8010181 (2)
 8011291 (2)
 HALYARD CLEAT 8010121 (2)
 8011291 (2)
 BASE 8010131 (4)
 8011291 (4)

BOW SPREADER BAR
 PLATES, BRIDLE BOW TANG 8010181 (4)
 INTERNAL STIFFENER 8010201 (4)

MAIN CROSSBAR
 BEAM STOP PLATES 8010181 (6)
 CLEAT 8010181 (1)
 PADEYES 8010181 (4)
 JAM CLEAT 8010131 (1)
 CLEATS, SWIVEL 8010131 (6)
 PADEYES 8010131 (4)
 END CAPS 8010201 (10)

REAR CROSS BAR
 PADEYE 8010181 (2)
 BEAM STOP PLATES 8010181 (6)
 CLEAT PLATE 8010131 (4)
 TRAMP LACE POSTS 8011231 (10)
 END CAPS 8010201 (8)

